

Pos. Nr. Pos.no.	Beschreibung Description	Art.-Nr. Art.no.	Preisgruppe Price bracket
1	Kessel komplett Betr.nr. 50 2146-4 Boiler ass. compl. loco no. 50 2146-4	153591	39
2	Kupplungsauflage Coupling cover	153576	5
3	TS - Fenster und Lichtleiter Part set window and light conductor	100677	9
4	TS - Kesselsteckteile Part set boiler plug-in parts	100678	13
5	Stirnlampe gross Front lamp big	149531	6
6	Kesselboden Boiler bottom	132706	12
7	Sandrohrsatz + Griffstangensatz Sand pipes + handles	120206	9
8	TS - Kesselleitungen und Ventile Part set boiler lines and valves	108329	10
9	TS - Kessel Part set boiler	100146	9
10	Lokgewicht Loco weight	109802	8
11	Schaltstange 0,4 x 93 mm Control rod	100171	4
12	Schaltstange 0,4 x 100 mm Control rod	100172	4
13	Schaltstange 0,4 x 37 mm Control rod	100169	4
14	Schaltstange 0,4 x 49,7 mm Control rod	100170	4
15	GF-Schraube M2x5 mm Self-tapping screw	114966	3
16	Führerhaus 50 2146-4 Driver's cab 50 2146-4	153592	12
17	Stirnlichtleiter Front light conductor	131724	3
18	Umlaufblech 50 2146-4 Running board 50 2146-4	153595	18
19	Ölkanne Oil can	92453	4
20	Windleitblech li+re Wind deflectors l+r	153593	9
21	Steuerung kpl. Reversing gear complete	153585	35
22	TS - Schiebereinsatz Part set slide set	153577	3
23	Zylinderblock links und rechts Cylinder block left and right	100168	12
24	Lampen li+re Lamp l+r	153563	10
25	Rauchkammerstütze Smoke chamber support	153585	7
26	Wasserpumpe 1 Water pump 1	106371	5
27	Drahtstift Tack	110641	4
28	Niet langer ansatz 3,2 mm Rivet long	117446	3
29	Steuerungsnieten kurz+lang Steering ass. rivets short+long	113252	8
30	TS - Griffstangen Part set handrails	100143	10
31	TS-Rauchfang Part set chimney	112021	6
32	Treppe Step	131124	3
33	Dachfenstergitter Roof grid	96762	8
<b>Sound</b>			
34	GF-Schraube M1,6x4 mm Self-tapping screw	114850	3
35	Lautsprecher Loudspeaker	129524	13
36	Lautsprecherplatine Loudspeaker PCB	133613	11
37	Kontaktstift Contact pin	132794	4

Änderungen in Konstruktion und Ausführung vorbehalten  
We reserve the right to change the construction and specification

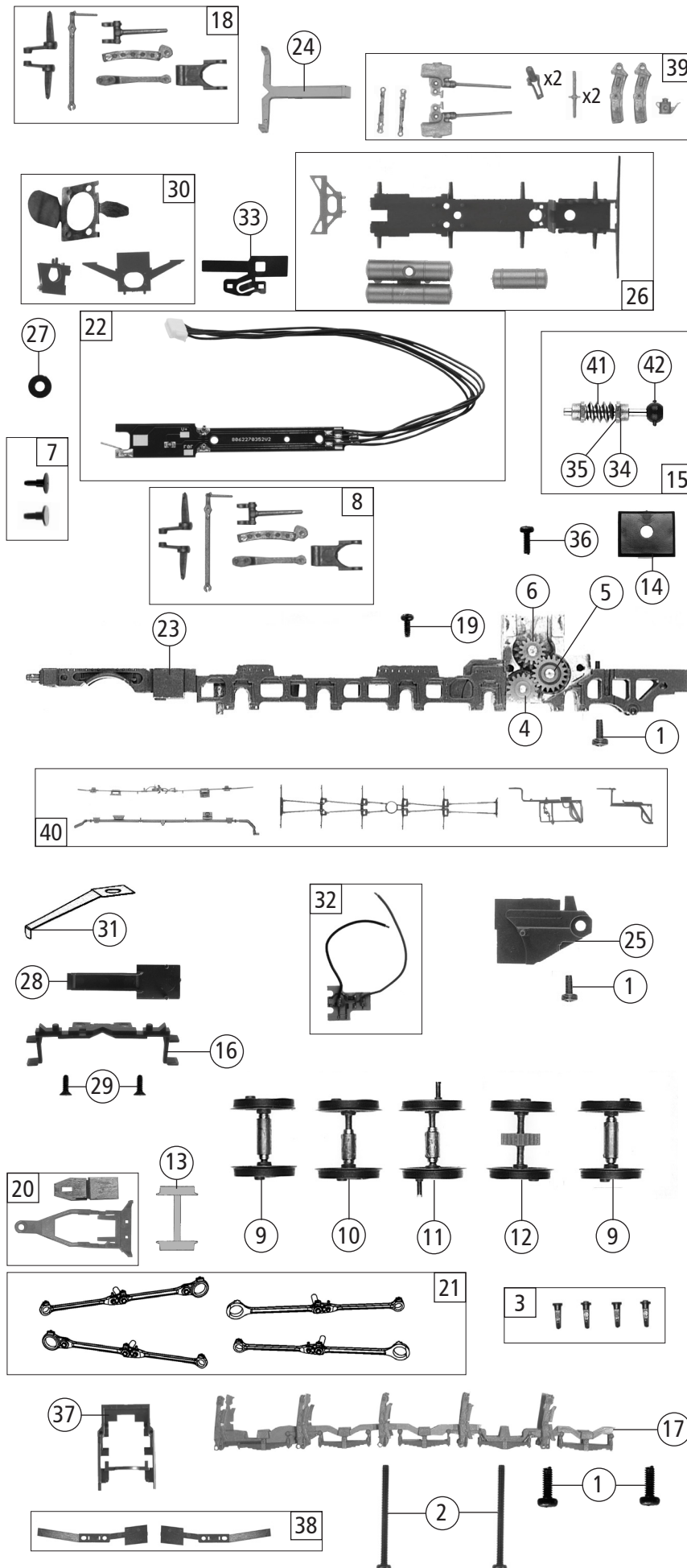

Pos. Nr. Pos.no.	Beschreibung Description	Art.-Nr. Art.no.	Preisgruppe Price bracket
1	GF-Schraube M2x4 mm Self-tapping screw	114877	3
2	GF-Schraube M2x25 mm Self-tapping screw	115533	3
3	TS-Bolzen Part set of bolt	138069	5
4	Zahnrad Z=17 Gear wheel	86409	5
5	Zahnrad Z=19 / M=0,4 Gear wheel	86417	3
6	Schneckenzahnrad Z=15/14 Worm gear wheel	86490	5
7	Puffer flach +gewölbt Buffer flat + vaulted	153567	5
8	TS - Gegenkurbel Part set - Counterweight	146620	8
9	Radatz 1/5 mit Achslager Wheelset 1/5 with axle bearing	153568	12
10	Kuppelradatz 2 mit Achslager Coupled wheelset 2 with axle bearing	153569	12
11	Treibradatz 3 mit Achslager Driving wheel 3 with axle bearing	153570	12
12	Kuppelradatz 4 mit Zahnrad Coupled wheelset 4 with gear wheel	153571	12
13	Vorlaufradatz Pony truck wheelset	153572	9
14	Schneckenkammerdeckel Worm gearbox cover	111987	4
15	Schneckensatz mit Kardankugel Set of worm gear incl. cardan ball	100132	13
16	Loktrepfen Loco treadles	153565	6
17	Bremsrahmen lackiert Brakes frame painted	153562	12
18	TS - Gegenkurbel Part set - Counterweight	146620	8
19	GF-Schraube M2x5 mm Self-tapping screw	114966	3
20	Vorlaufgestell Bogie frame	153573	12
21	TS - Kuppelstangen Part set - Coupling rods	153574	18
22	Lokplatine kpl. Loco printed circuit board ass.	151222	20
23	Lokgrundrahmen Loco basic frame	153560	17
24	Stirnlichtleiter Front light conductor	131122	5
25	Lokgetriebedeckel Loco gear cover	153561	12
26	TS-Umlauf Part set of running board	153566	10
27	Platinenring Ring for printed circuit board	125002	9
28	Lichtabdeckung Light cover	122502	3
29	SK-Schraube M1,6x4 mm SK-Screw	115161	3
30	Kesselstütze und Kont. Boiler support and contacts	117304	6
31	Vorlaufgestellfeder Bogie spring	125024	3
32	Lok Stirn LED Platine kpl. Loco front LED-PCB complete	131125	13
33	Radkontakt Wheel contact	131126	5
34	Lager für Schneckenachse Bearing for worm gear axle	89749	6
35	Beilagescheibe Washer	86108	3
36	GF-Schraube M1,6x4 mm Self-tapping screw	114850	3
37	Kontaktträger Contact support	153578	5
38	Radkontakt Li + Re Contacts L + R	124976	6
39	TS-Steuerung Part set-Reversing gear	146567	12
40	Bremsgestänge Brake rigging	153564	9
41	Schnecke Wormgear	86720	6
42	Kardankugel Cardan ball	95797	3

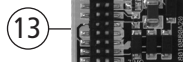
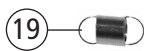
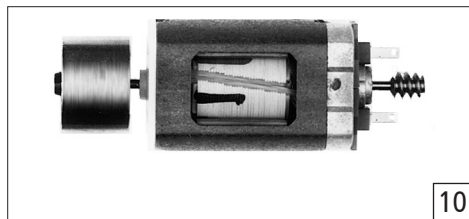
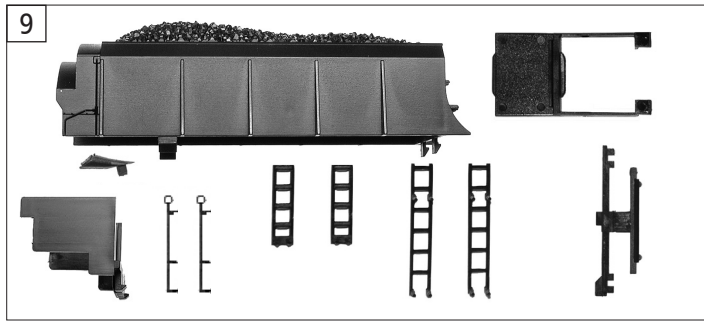
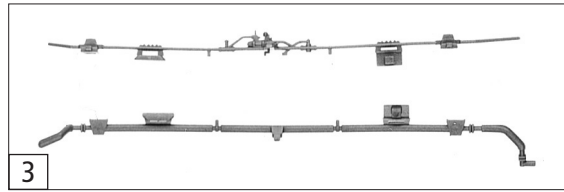

14 21

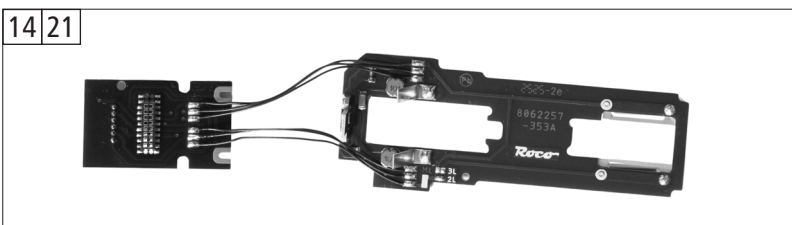

Pos. Nr. Pos.no.	Beschreibung Description	Art.-Nr. Art.no.	Preisgruppe Price bracket
7100039	DR BR 50	=	
7110039		=	🔊
7120039		~	🔊
1	Tendergehäuse Tender body	153580	14
2	Kardanschale kurz 1,5mm Cardan reception short	87129	4
3	Tenderleitungssatz Tender line set	153564	7
4	GF-Schraube M2x5 mm Self-tapping screw	114966	3
5	Tendergewicht Tender ballast	109405	8
6	Tenderlampe oben Upper tender lamp	109775	3
7	Spitzenlinse Frontside lens	109776	3
8	Kardanwelle, Kardanhülse Cardan shaft, Cardan reception	111765	4
9	TS - Tender Part set tender	120179	13
10	Motor komplett Motor assembly	85131	28
11	Bürstenfeder Carbon brush	114197	3
12	Kohlebürste Carbon brush	89743	6
13	Brückenstecker klein Connector small	130528	18
14	Tenderplatine kpl. LED Tender printed circuit board ass. LED	132976	24
15	GF-Schraube M1,6x6 mm Self-tapping screw	114836	3
16	GF-Schraube M1,6x10 mm Self-tapping screw	114881	3
17	Lok-Tenderkupplung Coupling between loco and tender	153575	8
18	Tender-Lichtleiter Tender light conductor	112025	4
19	Zugfeder Draw spring	86208	3
20	Doppelseitiges Klebeband Double sided adhesive tape	112629	3
<b>Sound</b>			
21	Tenderplatine kpl. LED Tender printed circuit board ass. LED	132977	28
22	Sounddecoder Sound-decoder	149667	39

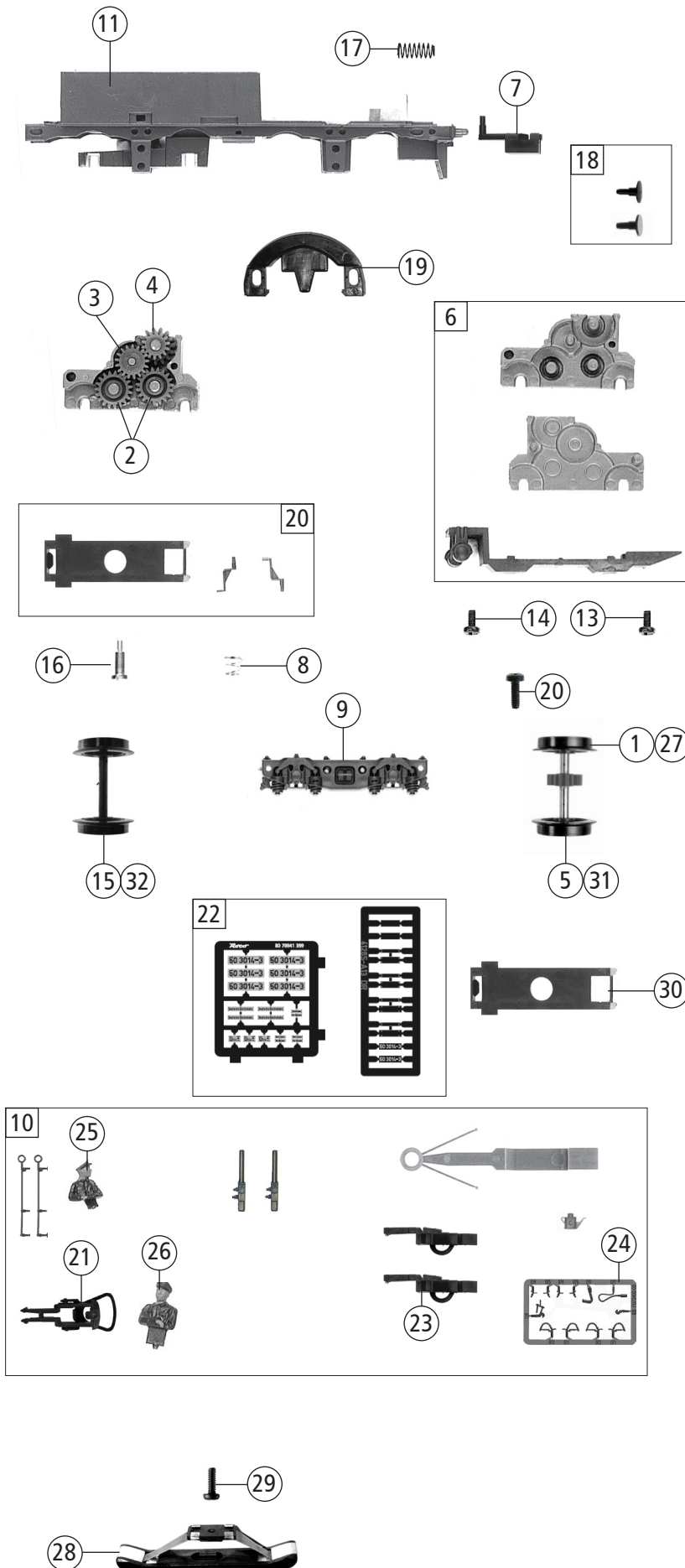

Pos. Nr. Pos.no.	Beschreibung Description	Art.-Nr. Art.no.	Preisgruppe Price bracket
7100039	DR BR 50	=	
7110039		=	🔊
7120039		~	🔊
1	Haftringsatz 10 Stk. 10,3-12,8mm Traction tyres set 10 pcs.	40069	10
2	Zahnrad Z=19 / M=0,4 Gear wheel	86417	3
3	Zahnrad Z=17 M=0,4 mm G Gear wheel	86418	5
4	Schneckenzahnrad Z=15/14 Worm gear wheel	86490	5
5	Tenderradsatz m.2Haftring. m. Zahnrad Tender wheelset w.traction tyres w.gearwheel	153583	11
6	Tendergetriebebesatz 3-teilig Tender gear set 3-parts	153581	13
7	Kupplungskammer Coupling reception	108225	4
8	Druckfeder Pressure spring	108226	3
9	Blende für Tender Bogie for tender	153584	4
10	Zurüstbeutel Bag with accessories	153597	15
11	Tenderrahmen Tender frame	153579	15
12	GF-Schraube M2x6 mm GF-Screw	114881	3
13	GF-Schraube M1 6x4 mm Self-tapping screw	114850	3
14	GF-Schraube M2x5 mm Self-tapping screw	114966	3
15	Radsatz o. Haftring o. Zahnrad Wheelset w/o traction tyre, w/o gear wheel	128614	9
16	Ansatzschraube M2x5 mm Flanged screw	85669	4
17	Bürstenfeder Brush spring	114197	3
18	Puffer flach + gewölbt Buffer round flat + vaulted	153567	8
19	Zentralverschluss Central locking clip	153596	18
20	Achsdeckel, Tritte Axle cover, treadles	153582	8
21	Standardkupplung Standard coupling	89246	6
22	Tafelsatz Set of panels	153598	12
23	Kurzkupplung Short coupling	115550	6
24	TS-Bremsschläuche und Zughaken Part set brake tubes & coupling hooks	139832	7
25	Lokführer seitlich Driver	89724	6
26	Heizer/Lokführer Driver	89725	6
<b>AC-Wechselstrom</b>			
27	Haftringsatz 10Stk.10,3-12,4mm Traction tyres set 10pcs. 10,3-12,4mm	40074	---
28	Schleifer 46 mm Center pick-up 46 mm	86031	14
29	GF-Schraube M1,6x5 mm Self-tapping screw M1,6x5 mm	115269	3
30	TS-Achsdeckel Part set axle cover	153600	8
31	Radsatz mit Haftringen mit Zahnrad Wheelset w.traction tyres w.gear wheel	153601	12
32	Radsatz ohne Zahnrad ohne Haftring Wheelset w/o gear wheel w/o trac.tyre	153602	10